

Miya

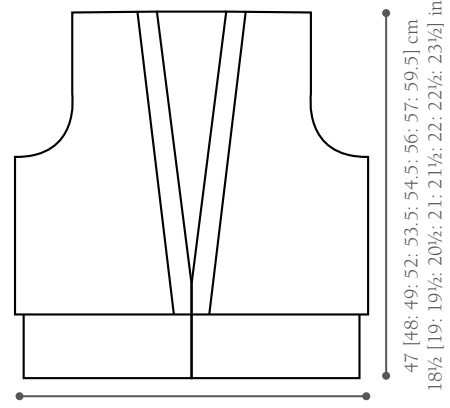

44 [48.5: 53.5: 57: 62.5: 66.5: 72: 76: 81] cm
17¼ [19: 21: 22½: 24½: 26¼: 28¼: 30: 32] in

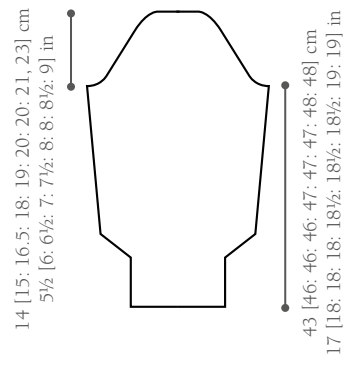

SIZE

To fit bust

71-76	81-86	91-97	102-107	112-117	122-127	132-137	142-147	152-157	cm
28-30	32-34	36-38	40-42	44-46	48-50	52-54	56-58	60-62	in

Actual bust measurement of garment

88	97	107	114	125	133	144	152	162	cm
34.5	38	42	45	49	52.5	56.5	60	64	in

YARN

Pure Cashmere

7	7	7	8	8	9	9	10	10	x 50gm
---	---	---	---	---	---	---	----	----	--------

(photographed in Dawn 92)

NEEDLES

1 pair 4mm (no 8) (US 6) needles

TENSION

23 sts and 32 rows to 10cm/4in measured over P2, K1 Rib using 4mm (US 6) needles

EXTRAS

Stitch holders

Stitch markers

3 buttons

Hartley

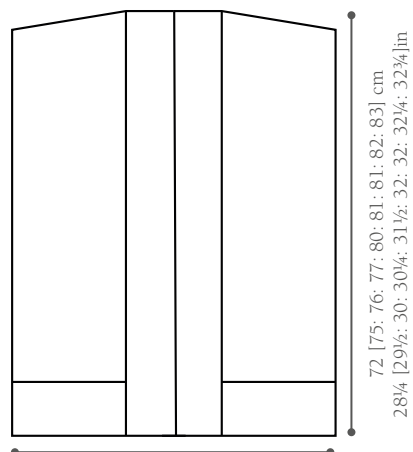

50 [55: 60: 65: 70: 75: 80: 85: 90] cm
19½ [21½: 23½: 25½: 27½: 29½: 31½: 33½: 35½] in

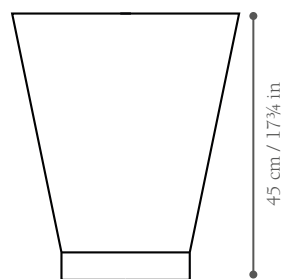

SIZE

To fit bust

71-76	81-86	91-97	102-107	112-117	122-127	132-137	142-147	152-157	cm
28-30	32-34	36-38	40-42	44-46	48-50	52-54	56-58	60-62	in

Actual bust measurement of garment

100	110	120	130	140	150	160	170	180	cm
39	43	47	51	55	59	63	67	71	in

YARN

Pure Cashmere

9	9	10	10	11	11	12	12	13	x 50gm
---	---	----	----	----	----	----	----	----	--------

(photographed in Port 93)

NEEDLES

1 pair each sizes 3.5mm (no 9 / 10) (US 4) and 3.75mm (no 9) (US 5) needles

TENSION

22 sts and 30 rows to 10cm/4in measured over st st using 3.75mm (US 5) needles

EXTRAS

Stitch holders

Stitch markers

•••• Joslyn



SIZE

To fit an average-sized adult woman's head

Actual circumference 48cm/19in

YARN

Pure Cashmere

1 x 50gm

(photographed in Potash 99)

NEEDLES

1 pair size 3.5mm (no 9/10) (US 4) needles

TENSION

23 sts and 34 rows to 10cm/4in measured over K1, P1 Rib using 3.5mm (US 4) when slightly stretched

SPECIAL ABBREVIATIONS

S2KP: Slip 2 sts tog knitwise as if to K2tog, K1, pass 2 slipped sts over K1. 2 sts dec'd

Calla

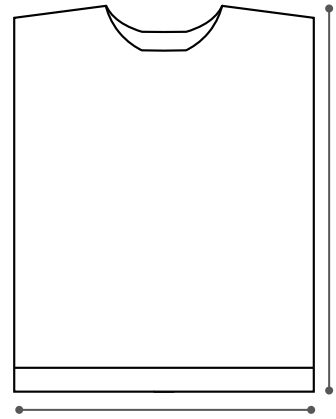

64 [66: 67: 68: 70: 72: 73: 75.5: 76.5] cm
25¼ [26: 26½: 26¾: 27½: 28¾: 28¾: 29¾: 30¼] in

45 [50: 53: 60: 65: 68.5: 76: 82: 86] cm
17¾ [19½: 21: 23¾: 25½: 27: 29¾: 32¼: 34] in

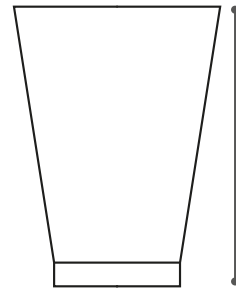

47 cm / 18½ in

SIZE

To fit bust

71-76	81-86	91-97	102-107	112-117	122-127	132-137	142-147	152-157	cm
28-30	32-34	36-38	40-42	44-46	48-50	52-54	56-58	60-62	in

Actual bust measurement of garment

90	100	106	120	130	137	152	164	172	cm
35.5	39	42	47.5	51	54	59.5	64.5	68	in

YARN

Pure Cashmere

10	11	11	12	12	13	13	14	15	x 50gm
----	----	----	----	----	----	----	----	----	--------

(photographed in Light 15)

NEEDLES

1 pair each sizes 3.5mm (no 9/10) (US 4) and 3.75mm (no 9) (US 5) needles

1 x 3.5mm (no 9/10) (US 4) circular needle

TENSION

28 sts and 30 rows to 10 cm/4 in measured over cable pattern using 3.75mm (US 5) needles

EXTRAS

Cable needle

Stitch markers

Note: st st rows at the lower hem and sleeve cuff edges are not included in the finished length measurements or shown on the schematics.

... Fleur



Front

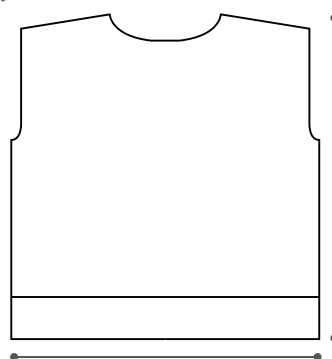

45 (50: 55: 60: 65: 70: 75: 80: 85] cm
17½ (19½: 21½: 23½: 25½: 27½: 29½: 31½: 33½] in

55 [56: 57: 59: 61: 62.5: 64: 65.5: 67] cm
21¾ [22: 22½: 23¼: 24: 24½: 25¼: 25¾: 26½] in

Back

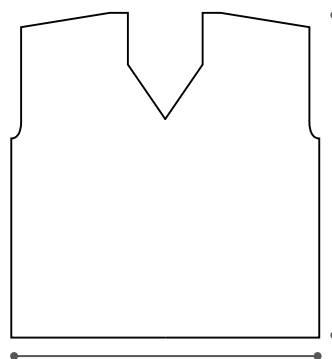

45 (50: 55: 60: 65: 70: 75: 80: 85] cm
17½ (19½: 21½: 23½: 25½: 27½: 29½: 31½: 33½] in

55 [56: 57: 59: 61: 62.5: 64: 65.5: 67] cm
21¾ [22: 22½: 23¼: 24: 24½: 25¼: 25¾: 26½] in

SIZE

To fit bust

71-76	81-86	91-97	102-107	112-117	122-127	132-137	142-147	152-157	cm
28-30	32-34	36-38	40-42	44-46	48-50	52-54	56-58	60-62	in

Actual bust measurement of garment

90	100	110	120	130	140	150	160	170	cm
35	39	43	47	51	55	59	63	67	in

YARN

Pure Cashmere

5	5	6	6	7	7	8	8	9	x 50gm
---	---	---	---	---	---	---	---	---	--------

(photographed in Flannel 100)

NEEDLES

1 pair each 3.5mm (no 9/10) (US 4) and 3.75mm (no 9) (US 5) needles

1 each 3.5mm (no 9/10) (US 4) and 3.75mm (no 9) (US 5) circular needle

1 size 3.75mm (no 9) (US 5) double-pointed needle for I-cord cast-off

TENSION

22 sts and 30 rows to 10cm/4 in measured over st st using 3.75mm (US 5) needles

EXTRAS

Stitch holders

Taylor



SIZE

To fit bust

71-97	102-127	132-157	cm
-------	---------	---------	----

28-38	40-50	52-62	in
-------	-------	-------	----

Actual circumference of garment at hem

117	143.5	172	cm
-----	-------	-----	----

46	56½	67¾	in
----	-----	-----	----

YARN

Pure Cashmere

3	4	5	x 50gm
---	---	---	--------

(photographed in Light 95)

NEEDLES

1 each 3.5mm (no 9/10) (US 4) circular needles 40cm and 80cm long

TENSION

23 sts and 34 rows to 10cm/4in measured over K1, P1 rib using 3.5mm (US 4) needles when slightly stretched

EXTRA

Stitch marker

... Caggie



SIZE

Finished wrap meas 41cm (16¼in) wide and 160cm (63in) long.

YARN

Pure Cashmere

A Light 95

2 x 50gm

B Chalk 94

5 x 50gm

NEEDLES

1 pair size 3.75mm (no 9) (US 5) needles

TENSION

22 sts and 30 rows to 10cm/4in measured over st st using 3.75mm (US 5) when slightly stretched

Note: Wind two equal balls of colour A for borders. When changing colours, twist yarns on WS to prevent holes in work.

Shay



SIZE

To fit an average-sized adult woman's head. Completed hat circumference 50cm/20in.

YARN

Rowan Pure Cashmere

1 x 50gm

(photographed in Light 095)

NEEDLES

1 pair 3.75mm (no 9) (US 5) needles

Set of 4 double-pointed 3.75mm (no 9) (US 5) needles

TENSION

22 sts and 30 rows to 10cm/4in measured over st st, using 3.75mm (US 5) needles

Dinah

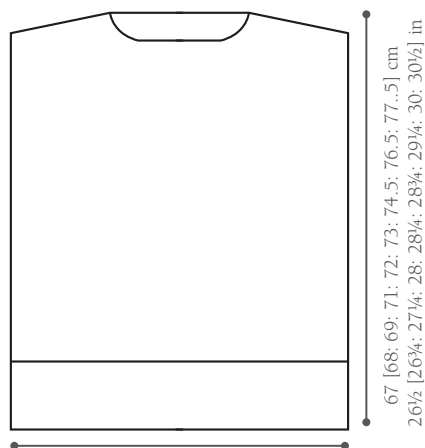

50 [55: 60: 65: 70: 75: 80: 85: 90] cm
19½ [21½: 23½: 25½: 27½: 29½: 31½: 33½: 35½] in

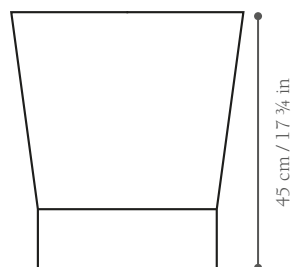

SIZE

To fit bust

71-76	81-86	91-97	102-107	112-117	122-127	132-137	142-147	152-157	cm
28-30	32-34	36-38	40-42	44-46	48-50	52-54	56-58	60-62	in

Actual bust measurement of garment

100	110	120	130	140	150	160	170	180	cm
39	43	47	51	55	59	63	67	71	in

YARN

Pure Cashmere

9	10	10	11	12	13	13	14	15	x 50gm
---	----	----	----	----	----	----	----	----	--------

(photographed in Potash 99)

NEEDLES

1 pair 3.75mm (no 9) (US 5) needles

1 x 3.75mm (no 9) (US 5) circular needle

TENSION

22 sts and 30 rows to 10cm/4in measured over st st using 3.75mm (US 5) needles

EXTRAS

Stitch holders

Stitch markers

Ina

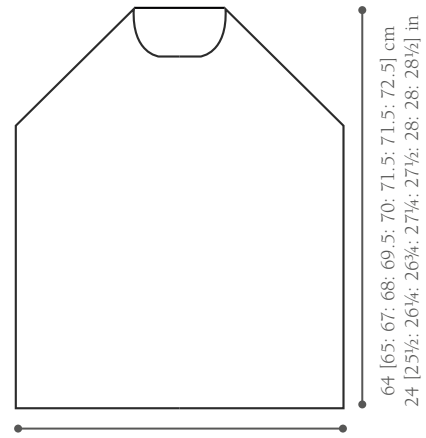

50 [53: 58: 61.5: 66.5: 72.5: 75.5: 80.5: 85.5] cm
19¾ [21: 22¾: 24¼: 26¼: 28¼: 29¾: 31¾: 33¾] in

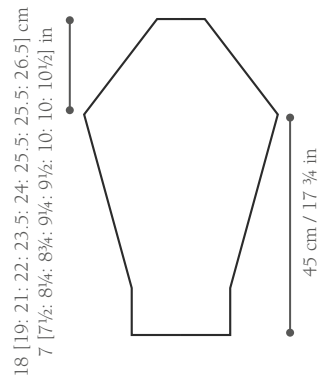

SIZE

To fit bust

71-76	81-86	91-97	102-107	112-117	122-127	132-137	142-147	152-157	cm
28-30	32-34	36-38	40-42	44-46	48-50	52-54	56-58	60-62	cm

Actual bust measurement of garment

100	106	116	123	133	145	151	161	171	cm
39.5	42	45.5	48.5	52.5	56.5	59.5	63.5	67.5	in

YARN

Pure Cashmere

12	12	13	13	14	14	15	15	16	x 50gm
----	----	----	----	----	----	----	----	----	--------

(photographed in Light 95)

NEEDLES

1 pair 3.5mm (no 9 / 10) (US 4) needles

1 size 3.5mm (no 9 / 10) (US 4) circular needle

TENSION

32 sts and 32 rows to 10cm/4in measured over K2, P2 Rib using 3.5mm (US 4) needles, when very slightly stretched

28 sts and 34 rows to 10cm/4in measured over stocking st using 3.5mm (US 4) needles

EXTRAS

Stitch holders

Stitch markers